

Assembly instructions

PO061 PopUp ARC 6x3 straight



The contents of the package:

- A. Rigid case: 2 pieces
- B. PopUp graphic: 8 panels
- C. PopUp frame: 1 piece
- D. Metal bars and textile bag: 27 pieces
- E. Spotlight: 2 pieces.

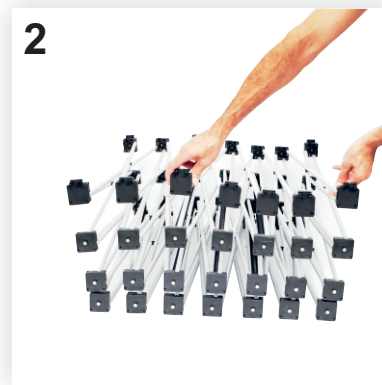

1. Place the PopUp frame (C) on the floor ensuring the row of the hanging pins is at the top-front of the frame, as in the picture.

2. Expand the frame (C) to its size by pulling up two of the black pieces of plastic. The structure will extend both vertically and horizontally.

3. After expanding the structure, it will look like in the picture.

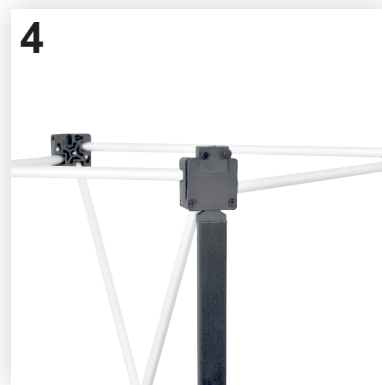
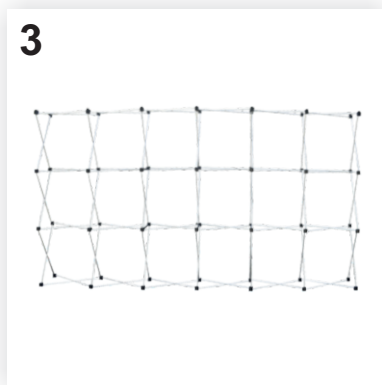

4. Attach the metal bars (D) from top to bottom starting from the black plastic nodes with pins: insert the tip of the metal bar into the slot under the black node, as in the picture.

5. The square at the bottom of the metal bar will be fixed into position by sliding it from right to left until it overlaps the black plastic node, like in the detailed image.

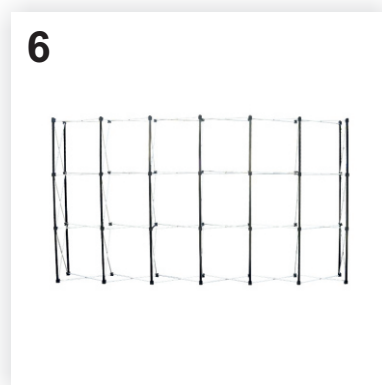

6. Continue in the same way attaching all the metal bars in a vertical line until you get nine vertical lines of three bars each: seven lines in the front and two lines in the sideback. Now the PopUp frame (C) is assembled

The pictures are for presentation only; your product can be slightly different!

Assembly instructions

PO061 PopUp ARC 6x3 straight



7-8. Hook on the spotlights (E) at the top of the PopUp structure in the left side of the aluminum bars intersection: insert the end of the spotlight support rod provided with grooves between the two aluminum bars (see the detailed picture). The spotlights can be mounted on top of any of the six columns of the system.

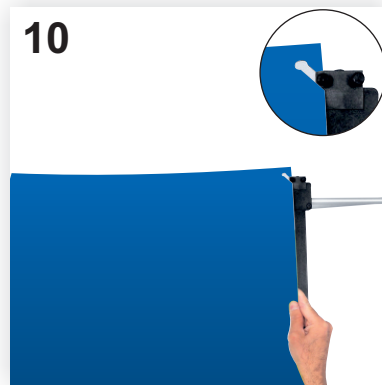

9. Gently take out each graphic panel (B) from the rigid case (A) by rolling it inwards to obtain a small roll. The panels are numbered to facilitate their positioning from left-to-right on the frame.

10. Hang each graphic panel in the pins at the top of the structure, as in the picture. For an easy mounting, it is recommended to start with the middle panels number 3 or 4.

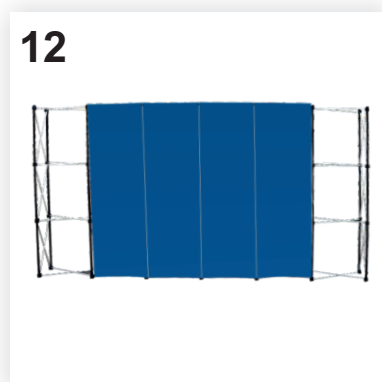
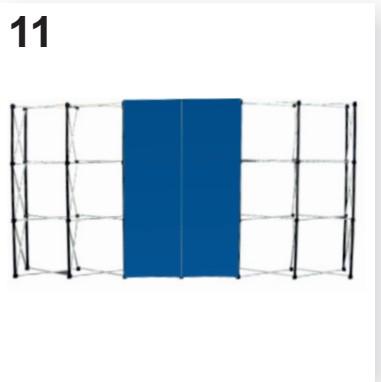

11-12. Unroll the graphic panel to its full length and attach it to the metal bars. The edge of each panel will be positioned on the middle of the metal bar, the other half remaining free for attaching the next panel.



13. After attaching the front panels, you can fix into position the side panels: 1 and 8. Bend the side panels in the shape of a semi-cylinder and hang them with one edge in front and the other behind the frame to form the sides of the PopUp.

The pictures are for presentation only; your product can be slightly different!